

Varenummer: 0106039
 Beskrivelse: Seeger låsering JV 22

Mål

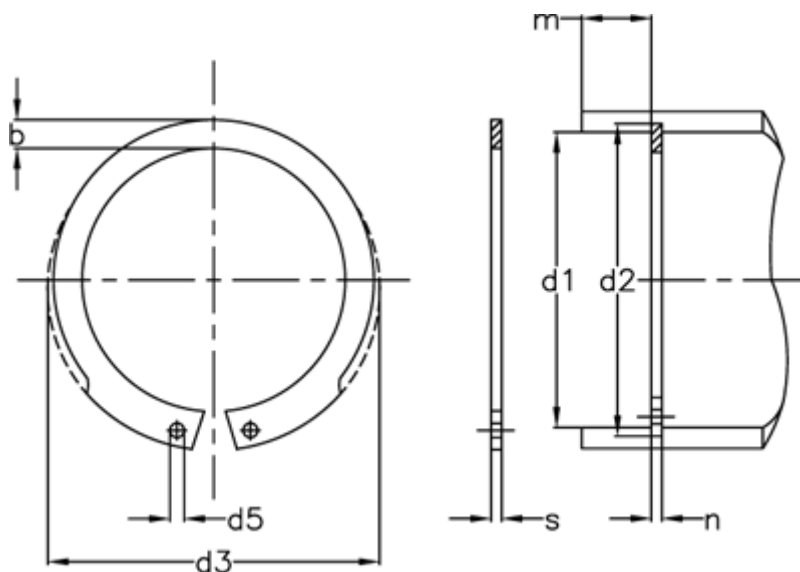

AN mm ²	= 17	FRg kN	= 2.8	Tang	= ZGJ-1
b	= 2.4	FR kN	= 7.5	tol	= -0.06
Betegnelse	= JV 22	g	= 1.0	tol	= +0,42-0,13
d1	= 22	K kN-mm	= 17.8	tol	= +0,15
d2	= 23.0	m min	= 1.10	tol	= 0.1
d3	= 23.5	Nominel træk	= 1.8	vægt kg/1000	= 0.83
d5 min	= 1.3	s	= 1.00		
FN kN	= 2.80	t	= 0.50		